

SAHARA

The specialist in AV solutions

Assembly instructions for Sahara Clever Touch CMS Trolley
Maximum TV fixing points up to 815mm X 600mm - Up to 100Kgs

Model No.
Sh1700126

Factory No.
FAB5585TR

- Read these instructions carefully before assembling this equipment.
- Check the equipment has been supplied with all parts and fixtures prior to assembly.
- Assemble in a suitable location.
- Two people will be required for assembly and three persons for installation of the screen on to the equipment.
- Do not attempt to alter or modify any part of the equipment or its attachments.
- Do not use if any parts are broken or appear to be damaged.
- Tighten all bolts and fixings securely with appropriately sized tools.
- Only use fixings provided with this bracket.
- Do not position the equipment close to sources of heat or moisture.

Component checklist

600mm aluminium extrusion assembled with joining plate x2



1200mm aluminium extrusion assembled with joining plate x2

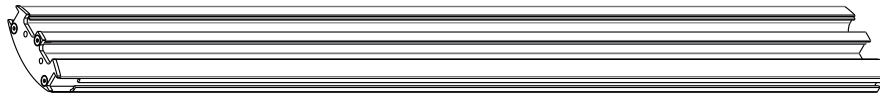

600mm trim inserts x6

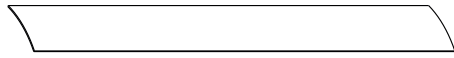

TV mounting plate slider x2

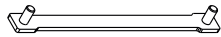

Welded base unit assembled with colour coded trims x1

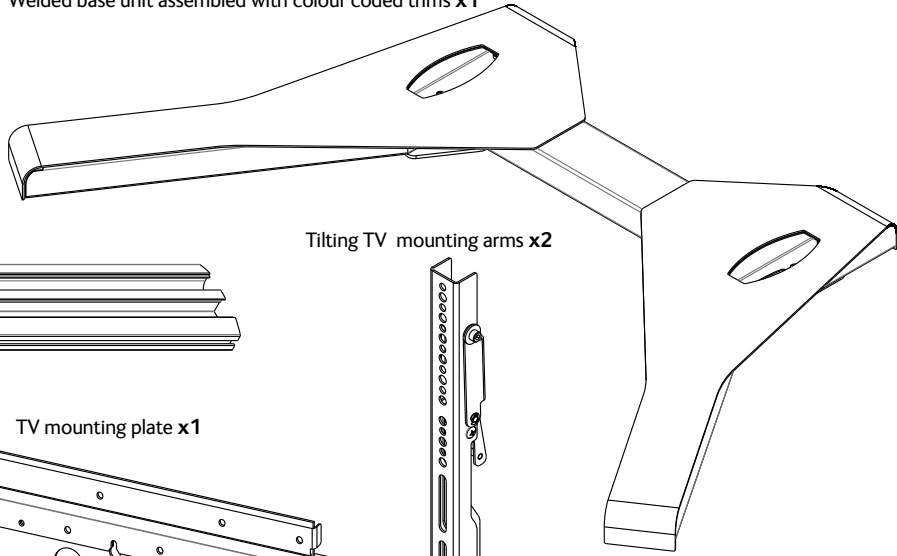

Tilting TV mounting arms x2

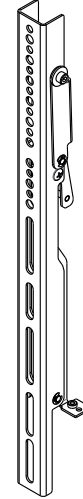

TV mounting plate x1

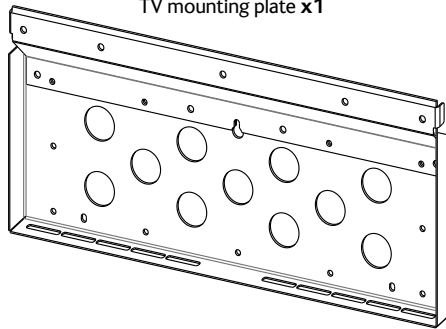

Width extender (holes) x2

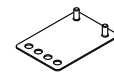

Width extender (slot) x2

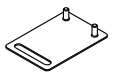

100mm braked castors x4

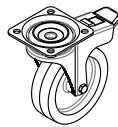

Glide feet x4



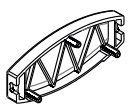

Upright trim pieces x2





Assembly kit checklist

 A - M6 x 12mm **X22**

 B - M6 washer **X16**

 C - M8 x 20mm **X6**

 D - M8 washer **X12**



 E - M8 x 16mm **X4**

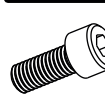
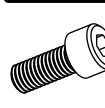
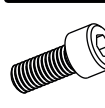
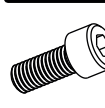

 F - M8 nut **X12**

TV Fixing Kit

 G - M6 x 30mm
 H - M6 x 50mm
 I - M8 x 30mm
 J - M8 x 50mm **X4**

 K - M8 washer **X4**

 L - M6 x 6.5mm
 M - M8 x 6.5mm **X4**

 N - M8 x 6mm
 O - M8 x 12.5mm **X4**

 P - M6 x 20mm **X2**

Trim inserts: You may find it easier to position the trim inserts in to the 1200mm uprights before fully assembling the trolley. The trims can be inserted after assembly but installing them during assembly by sliding them down the extrusions via the formed groove will reduce assembly time and allow forward planning of equipment cabling.

Installation of the trim inserts in to the 600mm uprights should be carried out at **step 7** of this instruction manual

Note: The trim pieces can be cut with a safety knife to make small entry and exit points for cables.

Top down view

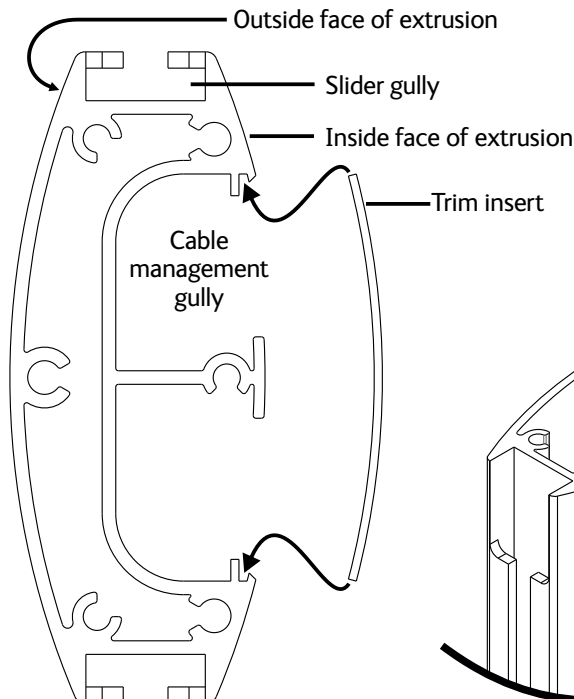

Isometric view

